

TS93 Cam Action Closer System

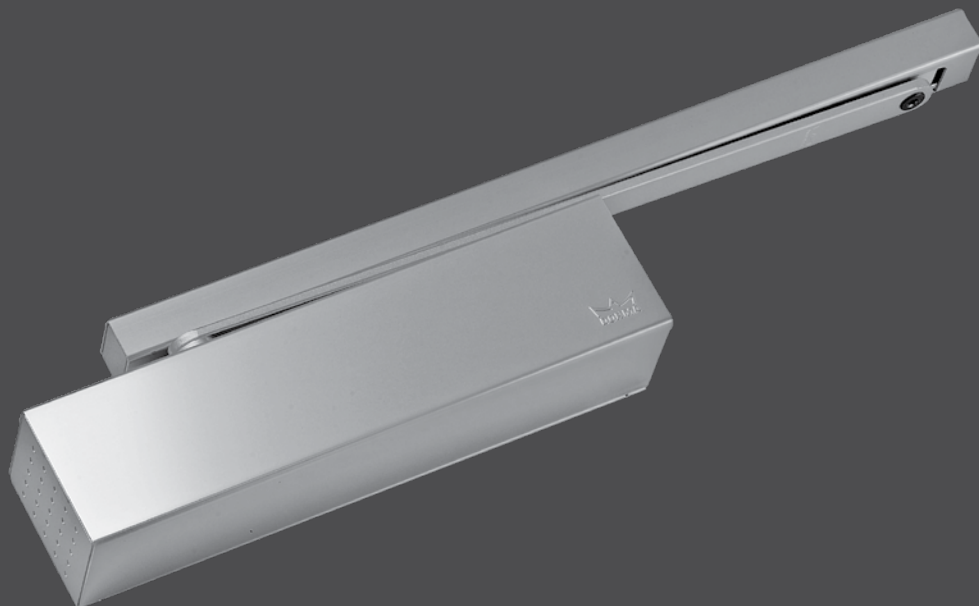

Cam Action Door Closer System

- 3 Technical Details/Specifications
- 3 Features
- 4 Pocket Door Closers
- 5 TS93

dormakaba USA quality and environmental management systems in Reamstown, PA and Steeleville, IL are certified to ISO 9001:2015 and ISO 14001:2015.



Technical Drawings

- 6 Track x Pull Side Frame Mounted
- 6 Track x Push Side Soffit Mounted
- 7 Track x Pull Side Frame Mounted Heavy-duty Spring Cushion
- 7 Track x Pull Side Door Mounted Heavy-duty Spring Cushion
- 8 Track x Push Side Soffit Mounted Heavy-duty Spring Cushion
- 9 90° Pocket Installation
- 9 90° Through 119° Pocket Installation
- 10 120° Through 170° Pocket Installation
- 11 180° Pocket Installation



The TS93 System in Contur Design

Representing the pinnacle of door closer systems with its unique cam and roller design.



Doors equipped with the TS93 will open much easier than doors with rack and pinion closers with track arms. The TS93 is a closer with regular arm operating efficiency and track arm aesthetics. When necessary, push side installation provides the benefits of track arm assemblies with the closer mounted to the door and the track mounted to the stop, creating a more tamper-resistant application.

Technical Details

- Available as TS9315 closers for interior and exterior barrier-free requirements (adjustable size 1–5).
- Available as TS9356 closers for greater closing force for exceptionally wide, tall, or heavy doors (size 5–6 +50% adjustment).
- Adjustable backcheck prevents uncontrolled opening of door.
- Adjustable delayed action extends the closing cycle to allow unobstructed passage through opening.
- Optional hold open, adjustable for degree of hold open and hold open force. Hold open is selectable on or off.
- SN3 sex nuts supplied standard for 1-3/4" thick door.

- Optional (CS) cushion limit stay for standard (T/PT) applications to assist slowing door in opening cycle (auxiliary stop required by others).

Certification

- UL and CUL listed under their continuing reinspection programs. 
- Certified to the requirements of ANSI/BHMA A156.4 Grade 1. 
- UL10C listed for positive pressure.
- Meets the requirements of ANSI/BHMA A117.1 and ADA for barrier-free accessibility. 
- California State Fire Marshall Approved (CSFM).

Specification

The TS93 System in Contur Design hydraulic surface applied closer with steel cam, roller, and adjustable spring, incorporating a track arm assembly. The TS93 will have two separate temperature compensating, noncritical adjustment valves to control sweep and latch closing speeds. Adjustable backcheck will take effect at approximately 65°. Adjustable hydraulic delayed action will be effective from approximately 120° to approximately 70°. The

TS9315 will be available with field-adjustable spring power from size 1 to 5 for barrier-free requirements. The TS9356 will be adjustable from size 5 to 6 with 50% adjustment. Maximum opening range will be approximately 175° for (T) and 110° for (ST) pull side installations and 110° for (PT/SPT) push side installations. Install the TS93 closer body on the door and the track arm assembly on the stop surface with the supplied bracket for push side (PT) applications. The TS93 will be non-handed.

Optional Specifications

All TS93 closers to have hold open, adjustable for degree of hold open and hold open force. All TS93 closers to have optional heavy-duty spring stop track arms to assist stopping the door in the opening cycle. Degree of stop to be field selectable.

Warranty

For details, refer to **Limited Warranty** on our website at go.dormakaba.com/Terms-DA

Finish

Standard Sprayed Finishes

- Aluminum: 689
- Bronze: 691 (Dull), 690 (Statuary), or 695 (Dark Duranodic)
- Gold: 696 (Satin)
- Black: 693
- Primed: 600

Optional Custom Color or Designer Color Finishes

Contact Customer Service.

Optional Plated/ Architectural Finishes

- Brass: 605 (Bright)
- Stainless Steel: 630 (Satin)

NOTE: Closer cover, arm, and track channel are plated. Cover end caps and track end caps are painted complementary or contrasting color.

REDUCED OPENING FORCE INSTALLATIONS CAUTION

Manual door closers, including closers certified to meet ANSI/BHMA A156.4, when installed and adjusted to conform to ADA or other reduced opening force requirements, may not provide sufficient power to reliably close and latch a door.

Refer to ED900 Low Energy Operator brochure to meet reduced opening force requirements without affecting closing power.

Feature	TS9315 T/TH	TS9356 T/TH	TS9315 ST/STH	TS9356 ST/STH	TS9315 PT/PTH	TS9356 PT/PTH	TS9315 SPT	TS9356 SPT
Adjustable spring size	1–5	5–6 +50%	1–5	5–6 +50%	1–5	5–6 +50%	1–5	5–6 +50%
Pull side application	●	●	●	●	-	-	-	-
Push side application	-	-	-	-	●	●	●	●
Controlled closing with two adjustable valves	175°–0° 7°–0°	175°–0° 7°–0°	110°–0° 7°–0°	110°–0° 7°–0°	110°–0° 7°–0°	110°–0° 7°–0°	110°–0° 7°–0°	110°–0° 7°–0°
Hydraulic backcheck	●	●	●	●	●	●	●	●
Hydraulic delayed action	●	●	●	●	●	●	●	●
Hold open	○ (TH)	○ (TH)	●	●	○ (PTH)	○ (PTH)	-	-
Spring cushion	-	-	○ (ST)	○ (ST)	-	-	●	●
Spring cushion with hold open	-	-	○ (STH)	○ (STH)	-	-	-	-

● yes - no ○ optional

TS93 PKT Pocket Door Closers

Applications accommodate opening angles ranging from 90°–180° while providing concealed hardware for doors that must be flush with the wall.

Technical Details (Pocket Doors)

- Available as TS9356 (size 5–6 +50% adjustment) closers for greater closing force for wider doors.
- Hardware is concealed when door is in pocket.
- Door surface is flush with corridor wall.
- No protruding edges.
- No dirt or debris buildup behind door.
- Open door fits completely into matched recessed wall pocket.
- Only 90° applications use pocket pivots.

Certification

The PKT applications are listed by U.L. under their continuing reinspection programs. PKT U.L. listings apply when used on doors that meet the specified door width and maximum weight.

Pocket Door

Application Disclaimer

dormakaba designs pocket door applications to be electronically held open under normal conditions. In the event of an alarm condition, the electric hold open will release—the door will close and latch under the power of the door closer. Meeting the fire life-safety code, Closing and Latching the Door, is the priority for our pocket door application and supersedes all accessibility requirements of A117.1. If low opening force is the priority for the application, an alternative door closer product should be considered in place of a pocket door application.

Specification

TS93 pocket door closers for doors required to be flush with the corridor wall. The pocket door closers offer applications for 90°–180° opening angles. All pocket door closers combined with an EM Series wall magnet create a held open flush

door until power is interrupted or the door is manually shut. The recommended method for hanging a 90° pocket door is by the use of 3 (each) pocket pivots 75520 for non-rated doors or 3 (each) 75523 for 20 minute or 3-hour rated fire doors. For doors beyond 90° up to 180°, 4-1/2" x 4-1/2" ball bearing butt hinges are recommended.

Finishes

Standard Sprayed Finishes

- Aluminum: 689
- Bronze: 691 (Dull), 690 (Statuary), or 695 (Dark Duranodic)
- Gold: 696
- Black: 693

Optional Plated Finishes

- Brass: 605 (Bright)
- Stainless: 630 (Satin)

NOTE: Closer cover, arm and track channel are plated. Cover end caps and track end caps are sprayed complementary or contrasting color.

Optional Custom Color or Designer Color Finishes
Contact Customer Service.

EM Series Wall Magnets



EM Series electromagnetic door holders are available with dual voltage capability and an adjustable catch plate, providing versatility for varying applications. Add-on catch plate extensions further enhance its flexibility. they release easily, even in applications meeting ADA requirements with minimal spring force closers. See EM Series brochure for details.

Warranty

For details, refer to **Limited Warranty** on our website at go.dormakaba.com/Terms-DA

Feature	TS9356 PKT 90	TS9356 PKT 90/119 OP	TS9356 PKT 120/170	TS9356 PKT 180
Adjustable spring size	5–6 +50%	5–6 +50%	5–6 +50%	5–6 +50%
Pull side application	●	●	●	●
Controlled closing with two adjustable valves	90°–0° 7°–0°	119°–0° 7°–0°	170°–0° 7°–0°	180°–0° 7°–0°
Hydraulic backcheck	●	●	●	●
Hydraulic delayed action	●	●	●	●

● yes

How to order TS93 Series

Arm Type

171°-180° Pocket Mount left handed	TPKT180L
171°-180° Pocket Mount right handed	TPKT180R
120°-170° Pocket Mount left handed	TPKT170L
120°-170° Pocket Mount right handed	TPKT170R
90°-119° Pocket Mount	TPKT119
90° Pocket Mount	TPKT90
Track hold open, pull side door mounted heavy-duty spring cushion	STH
Track hold open, push side soffit mounted	PTH
Track hold open, pull side frame mounted	TH
Track, push side soffit mounted heavy-duty spring cushion	SPT
Track, pull side frame mounted heavy-duty spring cushion	ST
Track, push side soffit mounted	PT
Track, pull side frame mounted	T

Painted

PNT	Special Sprayed Finish (must specify)
696	Gold
695	Dark Duranodic Bronze
693	Black
691	Dull Bronze
690	Statuary Bronze
689	Aluminum
600	Primed

Fastener Pack

SN3	Sex Nuts for 1-3/8" Door
SN4	Sex Nuts for 1-3/4" Door

Model **TS93** **15** **T** **SN3** **689**

Spring Size **56** **Options** **CS*** **605** **630**

Architectural Finish

Plated

*Available for use with T, TH, PT, PTH arms only.

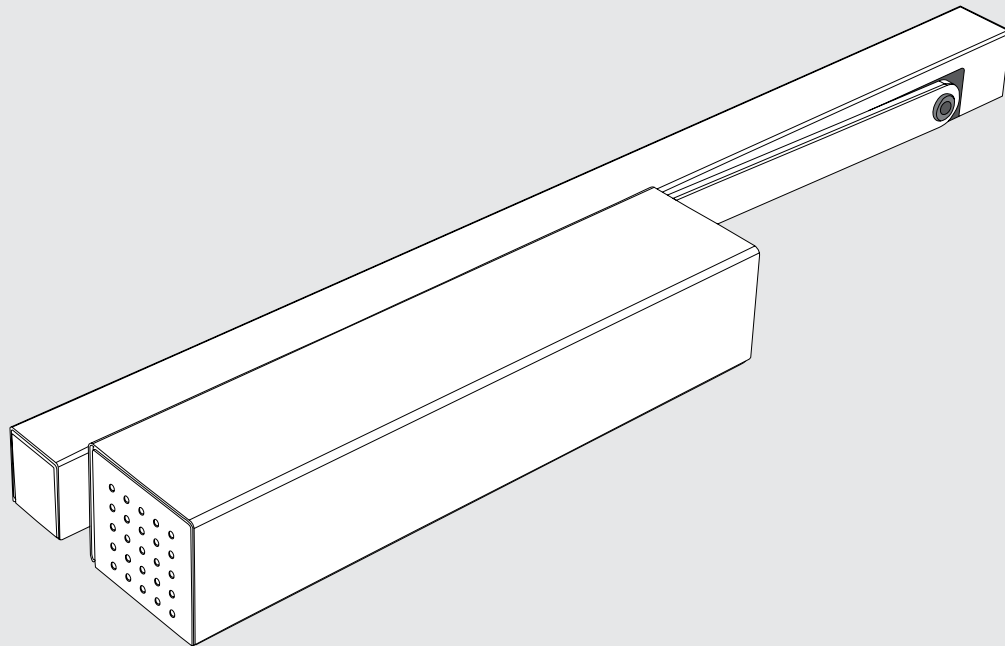

Technical Drawing Symbols & Notes

- Recommended application.
- ♿ Opening force 5 lb or less on interior doors
- N/A Not applicable/application not recommended

Track × pull side frame mounted

TS9315 T
TS9315 TH

TS9356 T
TS9356 TH

Size Selection Chart

Closer	Interior/ Exterior	Door Width							Maximum Opening	Approximate Backcheck	Approximate Delayed Action	Minimum Hold Open	Maximum Hold Open	Minimum Door Width
		2'-0" min.	2'-6" max.	3'-0" max.	3'-6" max.	4'-0" max.	4'-6" max.	5'-0" max.						
TS9315	Interior	•	•	♿	♿	♿	N/A	N/A	175°	65°-175°	120°-70°	50°	140°	24"
TS9356	Interior	N/A	N/A	N/A	N/A	•	•	•						

Track × push side soffit mounted

TS9315 PT
TS9315 PTH

TS9356 PT
TS9356 PTH

Size Selection Chart

Closer	Interior/ Exterior	Door Width							Closer	Maximum Opening	Approximate Backcheck	Approximate Delayed Action	Minimum Hold Open	Maximum Hold Open	Minimum Door Width
		2'-6" max.	3'-0" max.	3'-6" max.	4'-0" max.	4'-6" max.	5'-0" max.								
TS9315	Interior	•	♿	♿	♿	N/A	N/A	TS9315	110°	65°-110°	110°-70°	55°	105°	26"	
	Exterior	•	•	•	•	N/A	N/A								
TS9356	Interior	N/A	N/A	N/A	•	•	•	TS9356	110°	65°-110°	110°-70°	55°	105°	26"	
	Exterior	N/A	N/A	•	•	•	N/A								

NOTE: Although TS9315 Series closers have adjustable spring power to compensate for site conditions, it can not be guaranteed that adequate closing force will be obtained while complying with barrier-free opening force restrictions.

Track × pull side frame mounted heavy-duty spring cushion

TS9315 ST



TS9356 ST

(Hold open not available)

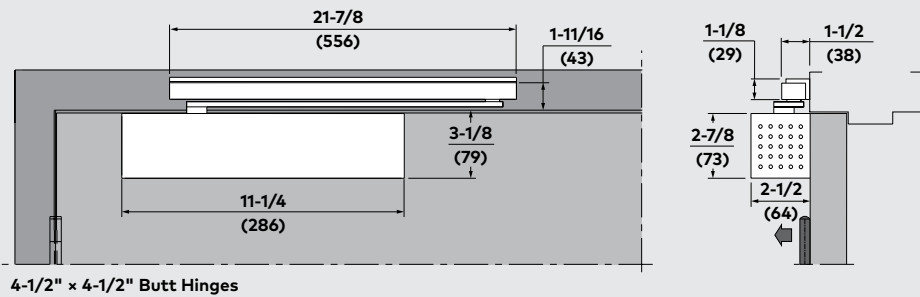

Size Selection Chart

Closer	Interior/Exterior	Door Width					Maximum Opening	Approximate Backcheck	Approximate Delayed Action	Minimum Hold Open	Maximum Hold Open	Minimum Door Width
		3'-0" max.	3'-6" max.	4'-0" max.	4'-6" max.	5'-0" max.						
TS9315	Interior	♿	♿	♿	N/A	N/A	110°	65°-110°	110°-70°	85°	110°	36"
TS9356	Interior	N/A	N/A	.	.	.						

Track × pull side door mounted heavy-duty spring cushion

TS9315 STH
TS9356 STH

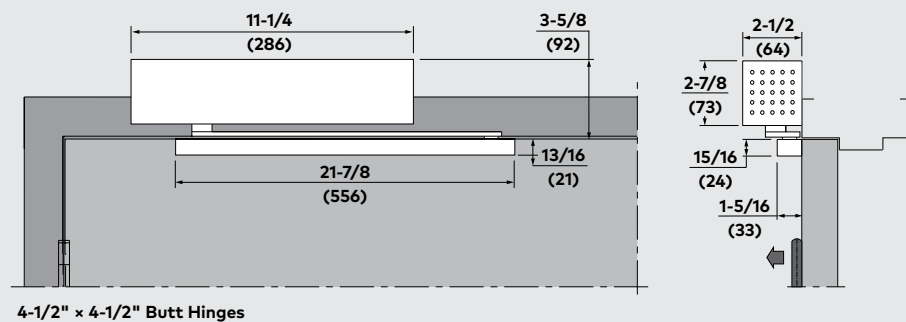

Size Selection Chart

Closer	Interior/Exterior	Door Width					Maximum Opening	Approximate Backcheck	Approximate Delayed Action	Minimum Hold Open	Maximum Hold Open	Minimum Door Width
		3'-0" max.	3'-6" max.	4'-0" max.	4'-6" max.	5'-0" max.						
TS9315	Interior	♿	♿	♿	N/A	N/A	110°	65°-110°	110°-70°	80°	105°	36"
TS9356	Interior	N/A	N/A	.	.	.						

NOTE: Although TS9315 Series closers have adjustable spring power to compensate for site conditions, it can not be guaranteed that adequate closing force will be obtained while complying with barrier-free opening force restrictions.
TS9356 - same selection chart and door width as above for the ST application.

Track x Push Side Soffit Mounted Heavy-duty Spring Cushion

TS9315 SPT



TS9356 SPT

(Hold open not available)

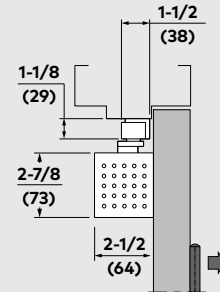
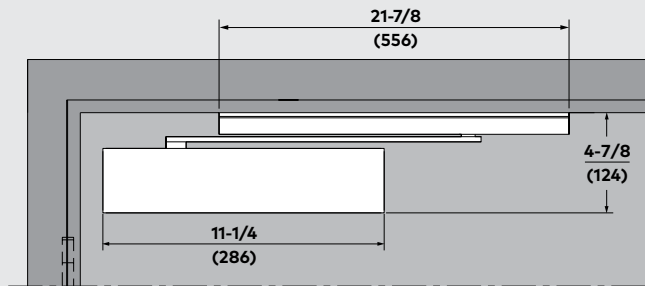

4-1/2" x 4-1/2" Butt Hinges

Size Selection Chart

Closer	Interior/ Exterior	Door Width				
		3'-0" max.	3'-6" max.	4'-0" max.	4'-6" max.	5'-0" max.
TS9315	Interior	♿	♿	♿	N/A	N/A
	Exterior	•	•	•	N/A	N/A
TS9356	Interior	N/A	N/A	•	•	•
	Exterior	N/A	•	•	•	n/A

Closer	Maximum Opening	Approximate Backcheck	Approximate Delayed Action	Minimum Hold Open	Maximum Hold Open	Minimum Door Width
TS9315	110°	65°-110°	110°-70°	85°	110°	42"

NOTE: Although TS9315 Series closers have adjustable spring power to compensate for site conditions, it can not be guaranteed that adequate closing force will be obtained while complying with barrier-free opening force restrictions.

90° Pocket Installation

TS9356 PKT 90

Size Selection Chart

Closer	Door Width Range	Maximum Weight
TS9356 PKT 90	3'-1" to 4'-6"	250 lb

The use of pocket pivots is recommended for hanging a 90° pocket door. Pocket pivots create optimum unobstructed space while creating a flush appearance for the door and frame.

NOTE: The EM-504 wall magnet has a 3-1/2" (89 mm) projection, the EM-505 x ER-1.5 has a 4" (102 mm) projection, the EM-508 has a 4-1/16" (103 mm) projection, and the EM-509 x ER-1.5 extension has a 3-5/16" (84 mm) projection. For pocket depths not equalling these projections, a shim by others is required for the door mounted catch plate.

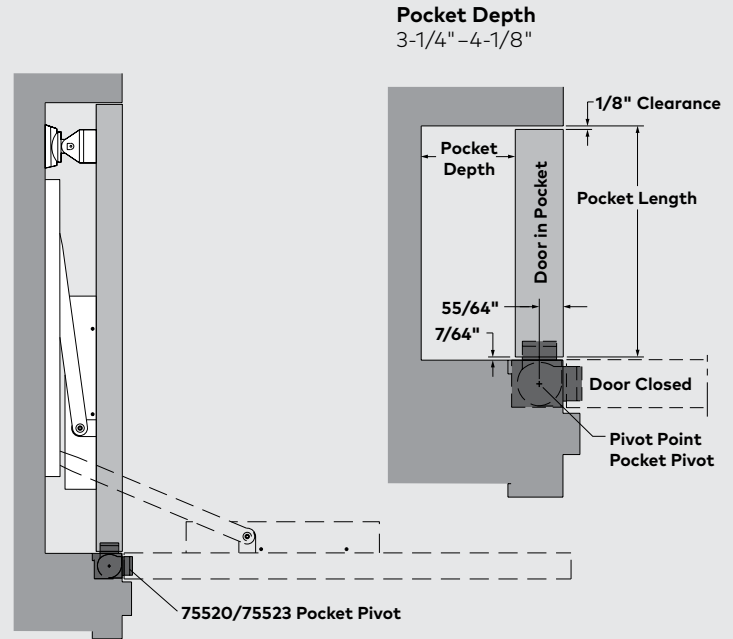

90° Through 119° Pocket Installation

TS9356 PKT 90/119 OP

Size Selection Chart

Closer	Door Width Range	Maximum Weight
TS9356 PKT 90/119 OP	2'-8" to 4'-1"	150 lb

The use of hinges is recommended for hanging the door. Hinges create optimum unobstructed space when the door is in the pocket. Alternatives, such as Offset Pivots, Swing Clear Hinges, and Continuous Hinges may be used. When using alternate methods, determine where the pivot point of the hinge or the pivot locates the door at the angle of opening when designing the pocket depth.

NOTE: The recommended EM 504 wall magnet has a 3-1/2" (89 mm) projection, and the pocket must be designed accordingly. EM-504 ordered separately.

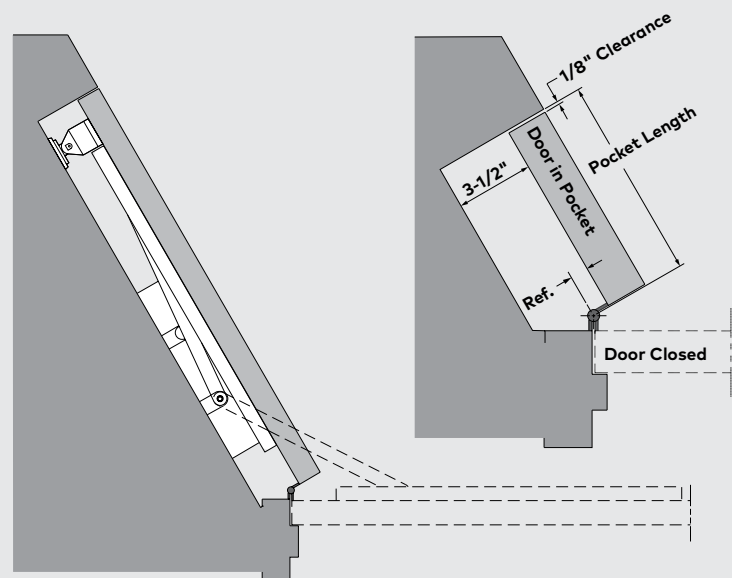

120° Through 170° Pocket Installation

TS9356 PKT 120/170

Size Selection Chart

Closer	Door Width Range	Maximum Weight
TS9356 PKT 120/170	2'-8" to 4'	150 lb

The use of hinges is recommended for hanging the door. Hinges create optimum unobstructed space when the door is in the pocket. Alternatives, such as Offset Pivots, Swing Clear Hinges, and Continuous Hinges may be used. When using alternate methods, determine where the pivot point of the hinge or the pivot locates the door at the angle of opening when designing the pocket depth.

NOTE: The recommended EM-504 wall magnet has a 3-1/2" (89 mm) projection, and the pocket must be designed accordingly. EM-504 ordered separately.

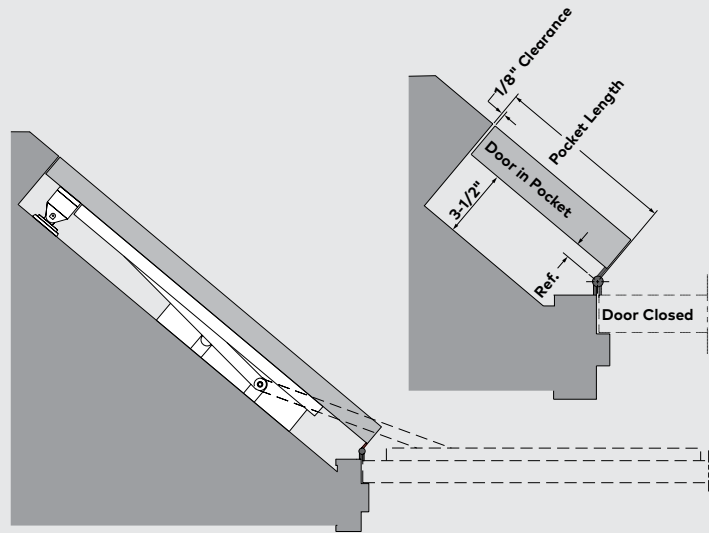

180° Pocket Installation

TS9356 PKT 180

Size Selection Chart

Closer	Door Width Range	Maximum Weight
TS9356 PKT 180	2'-8" to 4"	150 lb

The use of hinges is recommended for hanging the door. Hinges create optimum unobstructed space when the door is in the pocket. Alternatives, such as Offset Pivots, Swing Clear Hinges, and Continuous Hinges may be used. When using alternate methods, determine where the pivot point of the hinge or the pivot locates the door at the angle of opening when designing the pocket depth.

NOTE: The recommended EM 504 wall magnet has a 3-1/2" (89 mm) projection, and the pocket must be designed accordingly. EM-504 ordered separately.

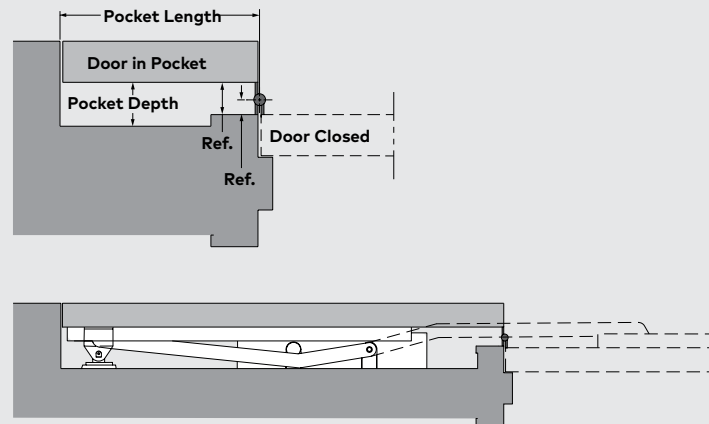



Additional Models



TS93 EMF

Fire/Life Safety

Compatible with new or existing fire/smoke control systems, the **EMR** model features a photoelectric detector and electromagnetic hold/release device.



TS93 EMR

The **EMF** model is an electromagnetic hold/release device only. See EMR/EMF brochure for more information.



TS93 GSR

Coordinating Pairs of Doors

The **TS93 GSR** models allow for the proper sequencing of pairs of doors equipped with astragals or exit devices, all housed within one device. See GSR brochure for more information.

dormakaba USA Inc.
6161 E. 75th St.
Indianapolis, IN 46250
800.523.8483
archdw.us@dormakaba.com

dormakaba Canada Inc.
105 Marcel-Laurin Blvd
Montreal, Quebec H4N 2M3
888 539-7226
orders.ca@dormakaba.com

dormakaba.us

